



Outdoor Network PTZ Dome Cameras

Quick Guide

V2.04

BOM:3101C0EW

Safety and Compliance Information

Installation and removal of the unit and its accessories must be carried out by qualified personnel. You must read all of the Safety Instructions supplied with your equipment before installation and operation.

Installation

- This device is a class A product and may cause radio interference. Take measures if necessary.
- Make sure the camera operates in an environment where the temperature and humidity meet requirements. Keep the camera from excessive pressure, vibration, moisture, dust, and intensive electromagnetic radiation.
- Use a power adapter or a PoE device that meets requirements. Otherwise, the device may be damaged.
- Make sure the length of the power cable between the power adapter and the camera is not too long, otherwise the voltage of the camera is lowered, causing the camera to work abnormally. If it is required to lengthen the power cable, lengthen the cable between the power adapter and the mains.
- Do not hold the tail cable by hand for weight bearing. Otherwise, the cable connector of the camera could be loosened.
- When connecting to an external interface, use an existing connection terminal, and ensure that the cable terminal (latch or clamp) is in good condition and properly fastened. Ensure that the cable is not tense during mounting, with a proper margin reserved to avoid poor port contact or loosening caused by shock or shake.
- The connectors of the tail cable must not be exposed. The bar cavity, waterproof box, corrugated pipe and PVC pipe must be fully sealed to protect the connectors from water. The waterproof components for the RJ45 plug must be used properly to protect the network cable from water.
- During the process of transportation, special attention is required for the protection of the transparent dome cover to prevent friction, scratch and

contamination, etc. In order to keep the cover clean, do not remove the protective film on the cover during mounting. After mounting is finished, remove the film before the device is powered on.

- Contact professionals for maintenance information. Do not attempt to dismantle the device by yourself. We shall not assume any responsibility for problems caused by unauthorized repair or maintenance.

Maintenance

- Caution: There will be risk of explosion if battery is replaced by an incorrect type. Dispose of used batteries according to the instructions.
- If there is dust on the front glass surface, remove the dust gently using an oil-free brush or a rubber dust blowing ball.
- If there is grease or a dust stain on the front glass surface, clean the glass surface gently from the center outward using lens cleaning cloth. If the grease or the stain still cannot be removed, use lens cleaning cloth dipped with detergent and clean the glass surface gently until it is removed.
- Do not use organic solvents, such as benzene or ethanol when cleaning the transparent dome cover.
- Make sure the lens cleaning cloth is clean itself.

Laser Safety (if applicable)

- Installation and maintenance must be carried out by trained and qualified personnel.
- The camera must be mounted at least 6 meters above the ground.
- To avoid the risk of fire, the laser illuminator must be clear of obstacles within a minimum range of 30 centimeters.
- Make sure laser is disconnected from power before examination.
- Never stare into beam or view through any optical instruments. Avoid exposure to direct or scattered radiation. Be especially cautious during installation and maintenance.
- Never view lasers without protective eyewear. Some lasers emit infrared or ultraviolet, which are invisible to human eyes.
- Keep flammable or explosive objects away from laser beam. Some lasers may ignite combustible materials and thus cause fire.

- Never direct laser at a person. Do not direct laser at glass. The reflection may still cause harm to human eyes.



- Never look at the transmit laser while the power is on. Never look directly at the fiber ports and the fiber cable ends when they are powered on.
- Use of controls or adjustments to the performance or procedures other than those specified herein may result in hazardous laser emissions.

Regulatory Compliance

FCC statements

This device complies with Part 15 of the FCC Rules. Operation is subject to the following two conditions: (1) this device may not cause harmful interference, and (2) this device must accept any interference received, including interference that may cause undesired operation.

Caution: The user is cautioned that changes or modifications not expressly approved by the party responsible for compliance could void the user's authority to operate the equipment.

Note: This equipment has been tested and found to comply with the limits for a Class A digital device, pursuant to part 15 of the FCC Rules. These limits are designed to provide reasonable protection against harmful interference when the

equipment is operated in a commercial environment. This equipment generates, uses, and can radiate radio frequency energy and, if not installed and used in accordance with the instruction manual, may cause harmful interference to radio communications. Operation of this equipment in a residential area is likely to cause harmful interference in which case the user will be required to correct the interference at his own expense.

LVD/EMC Directive



This product complies with the European Low Voltage Directive 2014/35/EU and EMC Directive 2014/30/EU.

WEEE Directive–2012/19/EU



The product this manual refers to is covered by the Waste Electrical & Electronic Equipment (WEEE) Directive and must be disposed of in a responsible manner.

Battery Directive-2013/56/EC



Battery in the product complies with the European Battery Directive 2013/56/EC. For proper recycling, return the battery to your supplier or to a designated collection point.

Default IP, Username and Password

- Default IP address: **192.168.1.13**
- Default username: **admin**
- Default password: **123456**



The default password is used for your first login. To ensure account security, please change the password after your first login. You are recommended to set a strong password (no less than eight characters).

Appearance Dimensions

The figures in the manual are for your reference only. The actual appearance may vary with the product model.

- IR PTZ Dome (for long range illumination)
- Smart IR PTZ Dome
- Starlight White Light PTZ Dome
- Starlight Full Spectrum PTZ Dome
- Starlight IR PTZ Dome

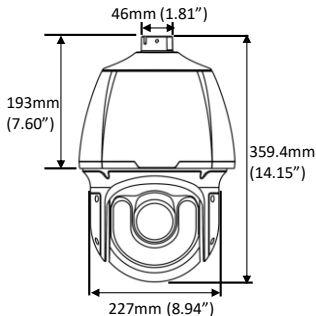

Laser PTZ Dome

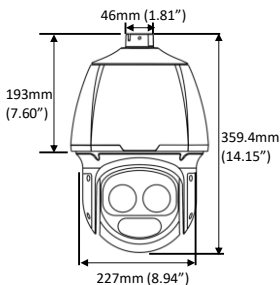

IR PTZ Dome (for short range illumination)

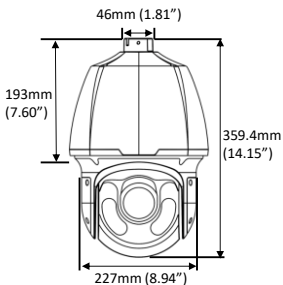

Cable Connection

All cables are tagged to indicate their functions separately. You can connect cables by referring to the following figure. The appearance and tail cable may vary with device model.

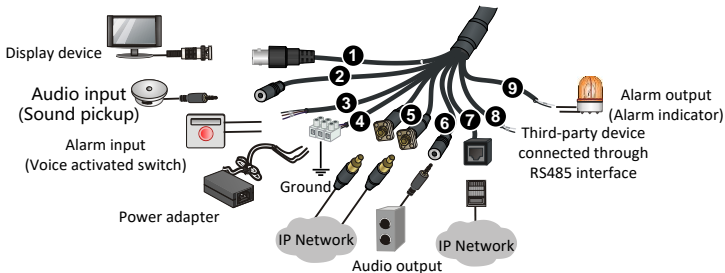

- Certain models support Ethernet interface (10M/100M Base-TX Ethernet, RJ45).
- Certain models support optical interface (SFP module) and FC fiber connector (fiber optical adapter included).
- The dome camera is delivered without the SFP optical module installed. For the details about mounting the optical module, see Mount SFP Optical Module (For Certain Models).
- Please disconnect the power before mounting. You can connect the camera to the network through the optical interface or the Ethernet interface after mounting and switch two interfaces without disconnecting the power. The two interfaces cannot be used at the same time.
- For the detailed information about the specifications, see the datasheet.

Mount Your Camera

The following figures are for your reference only. See the actual product for details. Mounting processes for dome cameras are similar, differences will be described separately if there is any.

Check Before Mount

Before mounting your camera, check the device model, accessory types and quantities against the packing list to ensure components are complete.

Figure 1 Camera components

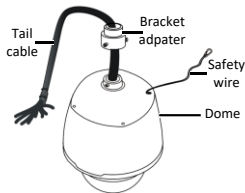

Verify the bearing capacity of the mounted position

Verify that the mounted position meets the bearing requirements. Otherwise, you are advised to reinforce the mounted position for the device weight. For more information, see the product datasheet.

Verify the lightning protection and grounding requirements

- Select proper lightning protection devices for the power supply, audio and video signals interfaces, and RS485 interfaces.
- See Table 1 to ground the terminal properly.

Cable Requirements

Network cable

10M/100M Ethernet CAT 5/5E UTP cables are applicable to the

ANSI/EIA/TIA-568A/B and ISO/D.

Eight wires in the network cable need to be inserted in parallel into the top of the cable connector. The cable connector needs to be crimped in position. When the cable connector is in position, ensure that the metal pieces of the cable connector are parallel to each other and the clamp of the cable connector is intact.

Optical fiber

The optical module in the camera should match that of the third-party device (such as a switch), in terms of fiber mode and emission/receiver wavelength. Ensure the transmission distance of the optical module is greater than the distance actually required.



For a dome camera with optical module, it should be connected to the single mode optical fiber instead of multimode optical fiber.

For a proper optical fiber connection, check that:

- During SFP module installation, do not bend the fiber at sharp angle (make sure that the curvature of the fiber is greater than 90 degrees).



- When mounting the tail cable adapter, ensure that the optical fiber is not clamped by the device. Otherwise, the optical fiber could be damaged.
- Avoid excessively bending the optical fiber during installation. If the optical fiber is too long, coil the optical fiber. Ensure that the coil diameter is greater than 60 mm and the curvature is greater than 90 degrees.

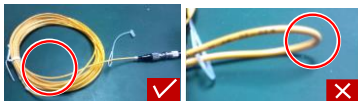

- Select a high-quality fiber connector. If a non-standard fiber connector without chamfering is used, internal ceramic sleeves such as the optical module, fiber optic adapter, or optical splitter could be damaged.
- Ensure that the fiber connector is in good condition, the latch is not disrupted and keeps elasticity, and the connection to the peer end is proper.



- Before connecting an optical fiber, check that there is no obvious surface defect such as stain, scratch, dent, or pit. If the fiber connector, fiber optic adapter, or optical module is dirty, clean it with alcohol and clean cotton (or a clean cotton rod).
- Choose a fiber optic adapter according to the fiber connector model. Use an optical splitter when cascading devices.
- To connect a fiber connector and a fiber optic adapter, align the fiber connector with the slot in the fiber optic adapter to ensure proper interconnection.



Power cable

Table 1 Phoenix Connector Description

Power Supply	Cable Color
<ul style="list-style-type: none">IR PTZ dome (for long range illumination)/smart IR PTZ dome/laser PTZ dome/starlight white light PTZ dome/starlight full spectrum PTZ dome/starlight IR PTZ dome: 24VAC 3A/24VDC 2.5AIR PTZ dome (for short range illumination):24 VAC 2.2A/24 VDC 2.5A	The anode and the cathode are not distinguished for phoenix connectors of red and black cables.
	GND: yellow-green color. Note: GND is used to ground the camera. Ensure that GND is connected to a reliable grounding point.

Table 2 Power Loss on the Cable for Different Lengths and Core Diameters

Core Diameter (Unit: mm)	Distance (Unit: m)	Power (Unit: W)	0.80	1.00	1.25	2.00
30			28	45	72	183
40			21	34	54	137
50			17	27	43	110
60			-	22	36	91

Core Diameter (Unit: mm)	Distance (Unit: m)			
	0.80	1.00	1.25	2.00
70	-	19	31	78
80	-	-	27	68
90	-	-	24	61
100	-	-	21	55



Data listed in 0 is applicable to power cables that use 24 VAC /24 VDC power supply. The item Core Diameter indicates the conductor diameter.

Process Map

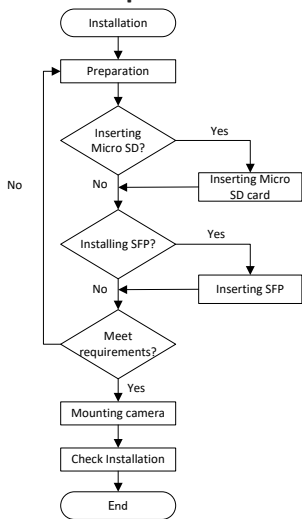

- Make sure the camera is disconnected from the power during installation.
- Accessories such as the wall mount and the pendant mount brackets may be necessary during mounting. For supported models, refer to the recommended list provided by your dealer.
- The wall bearing capacity and the bracket length must satisfy mounting requirements. Select a proper mount mode according to the actual situations.

(Optional) Insert Micro SD Card

Please install the Micro SD card first, then format the Micro SD card in the software interface before use. Disconnect the camera from power before installation, otherwise the camera or the Micro SD card might be damaged.



- For details about recommended SD card specifications, contact your dealer.
- The following figures are only for your reference. For actual Micro SD card slot position, see the delivered camera.

Unscrew the four cross-recessed screws to remove the back cover. Insert the Micro SD card, and then mount the back cover. Properly mount the waterproof ring in position.

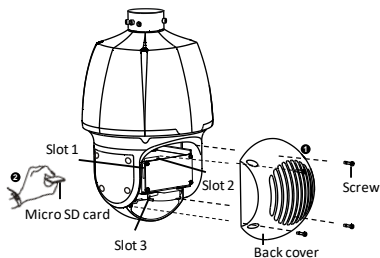

- Slot 1: WDR IR PTZ Dome/Smart IR PTZ Dome
- Slot 2: Laser PTZ Dome/IR PTZ Dome
- Slot 3: Starlight White Light PTZ Dome/Starlight Full Spectrum PTZ Dome/Starlight IR PTZ Dome

Mount SFP Optical Module (For Certain Models)

1. Unscrew the tail cable adapter by loosening four screws.
2. Turn over the tail cable adapter unit, and remove the dustproof lid.

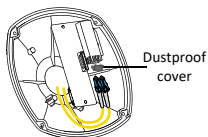
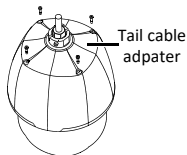

3. Insert the SFP optical module recommended by your dealer.

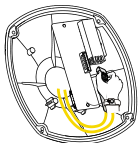

4. Connect the optical fiber plug to the SFP module, and then replace the tail cable adapter unit.

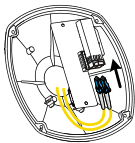

- Select the optical module by referring to the recommended list.
- During connection, ensure that the optical fiber plug of the optical module matches the optical interface of the tail cable. You may refer to information on the label attached to each optical interface.

Wall Mount

1. Mark the positions of the holes by referring to the mount points of the bracket and lead the cable through the hole on the wall. Then drill holes and knock the expansion bolts.

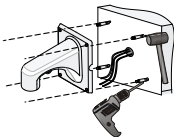

2. Turn the bracket adapter (G1 ½ male thread) in and secure the racket adapter with a screw.

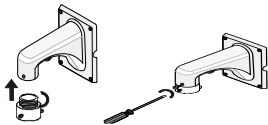

3. Attach the safety wire to the bracket and the dome. And Lead the tail cable through the bracket.



4. Attach the dome to the bracket adapter.

Slide camera holders into inner track and turn camera till it is blocked by bracket adapter screw.

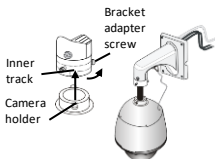

5. Secure the dome with two M5 screws.

M5
screw



6. Connect the cables and attach the bracket to the wall with flat pads, washers and nuts.

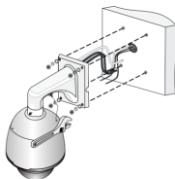



- When mounting the camera, please install the bracket adapter to the bracket first and then mount the camera to the bracket.
- Tighten all the screws to hold the dome securely.
- For waterproofing, apply sealant between the dome and the bracket, wall veneer slits, and leading-out holes of the wall.
- The following section describes concealed installation. To implement open installation, directly lead the cable out from the cable slot at the flank of the bracket.
- The following takes wall mount as an example.

Reset Camera to Default Settings

Remove the back cover first. Press and hold the RST button for about 15 seconds to restore factory default settings. The RST button only works within ten minutes after the camera is powered on.

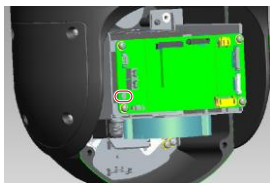

Waterproof Components for an RJ45 Plug

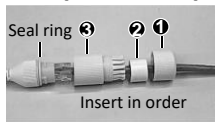

Attach the seal ring to the Ethernet interface. Mount the waterproof components in order. Then insert the cable into the Ethernet interface and screw the waterproof bolt in.



You can crimp the inner wires of the cable with the RJ45 plug first and then cover the waterproof components. You may also cover the waterproof components first.



Access Your Camera

Before you begin, check that:

- Your camera is operating properly and connected to the network.
- The PC you are using is installed with Internet Explorer 7.0 or later.

Follow steps to access your camera through the Web interface:

1. Open your browser, input the IP address of your camera in the address bar and then press **Enter** to open the login page.
2. Enter the username and password and then click **Login**.



- Install the ActiveX at your first login. When the installation of the ActiveX is completed, open your IE to log in.
- For your first login with Windows 7, if the system does not prompt you to install ActiveX, follow these steps to turn off UAC: click the **Start** button, and then click **Control Panel**. In the search box, type **uac**, and then click **Change User Account Control Settings**. Move the slider to the **Never Notify** position, and then click **OK**. After UAC is turned off, log in again.
- If the installation failed, open **Internet Option** in IE before login. Click the **Security** tab, click **Trusted sites**, and then click **Sites** to add the website. If you use Windows 7, you need to save the setup.exe to your PC first, and then right-click the file, select **Run as administrator**, and then install it according to instructions.